



SZYNA CS

CHARAKTERYSTYKA PRODUKTU

PRODUCT PROFILE / ARTIKELPASS

Kod produktu / Article Number / Artikelnummer:

Wymiary / Dimension / Maße: 20 x 20 mm

Waga / Weight / Gewicht: 0,235 kg / m

Maksymalne obciążenie / Maximum load / Maximale last:

15 kg / m

Długość / Length / Länge: 3,66 m, 4,88 m, 6,10 m

Dostawca / Supplier / Zuliefer: Lookban

Kompozycja / Composition / Material: Aluminium

OPIS

DESCRIPTION / BESCHREIBUNG



PL 

Szyrna wykonana z wysokiej wytrzymałości aluminium malowana proszkowo na dowolny kolor RAL.

Istnieje możliwość gięcia szyny po łuku lub punktowo (minimalny promień gięcia 20cm). Szyrna przystosowana jest do różnych rodzajów kotar; klasyczne, plisowane, fałdowane. Sposób montażu szyny; sufitowy lub ścienny na dedykowanych uchwytach z możliwością regulacji odstępów od ściany.

Funkcjonalność Klick System – zatraskiwanie suwaków oraz uchwytów na szynie znacznie przyspiesza montaż szyn i zawieszanie tkanin

Prosta i szybka instalacja do ściany i sufitu dzięki uchwytom Smart Klick.

Gięcie szyn: kątowe o promieniu 20 cm oraz łuk cięgly w płaszczyźnie poziomej

Ramiona wygięte CS gwarantują lepsze zaciemnienie wnętrza taśmą marszczącą lub na haczykach typu Mikroflex

Obsługa ciężkich tkanin prętami do przesuwania o długości 92,122 i 152 cm

System umożliwia także zawieszanie tkanin na Easyfold (przejdź do FES) Maksymalny ciężar

UK 

Rail made of high strength painted aluminum powder coated in any RAL color.

It is possible to bend the rails in an arc or pointwise (minimum radius bending 20cm). Rail adapted it is for different types of curtains; classic, pleated, folded. Rail mounting method; ceiling or wall mounted on dedicated brackets with adjustable gap from the wall.

Klick System functionality - snapping zippers and handles on the rail significantly speeds up the assembly rails and hanging fabrics

Simple and quick installation for wall and ceiling thanks to the handles Smart Klick

Bendable; it can be curved and reversed curved using a 20 cm (8") radius

CS curved arms guarantee better interior darkening with a shirring tape or on Microflex hooks

Handling heavy fabrics with rods for sliding, length 92,122 and 152 cm

Can also be used for Forest Easyfold Systems and accordiafold drapery systems

DE 

Schiene aus hoch Stärke lackiertes Aluminium pulverbeschichtet in jeder RAL-Farbe.

Es ist möglich, die Schienen in einem Bogen zu biegen oder punktweise (minimaler Radius 20 cm biegen). Schiene angepasst es ist für verschiedene Arten von Vorhängen; klassisch, plissiert, gefaltet. Schienenmontagemethode; Decke oder Wandmontage an speziellen Halterungen mit einstellbarem Spalt von der Wand.

Klick System Funktionalität - Reißverschlüsse und Griffe auf der Schiene beschleunigt die Montage erheblich Schienen und hängende Stoffe

Einfache und schnelle Installation für Wand und Decke dank der Griffe Smart Klick.

Sammelschienenbiegung: eckig mit Radius 20 cm und ein durchgehender Bogen in der Ebene horizontal

CS gebogene Arme garantieren bessere Innenverdunkelung mit Raffensband oder auf Mikroflexhaken

Umgang mit schweren Stoffen mit Stangen zum Gleiten Länge 92,122 und 152 cm

Das System erlaubt auch hängende Stoffe auf Easyfold (Gehe zu FES) Maximales gen



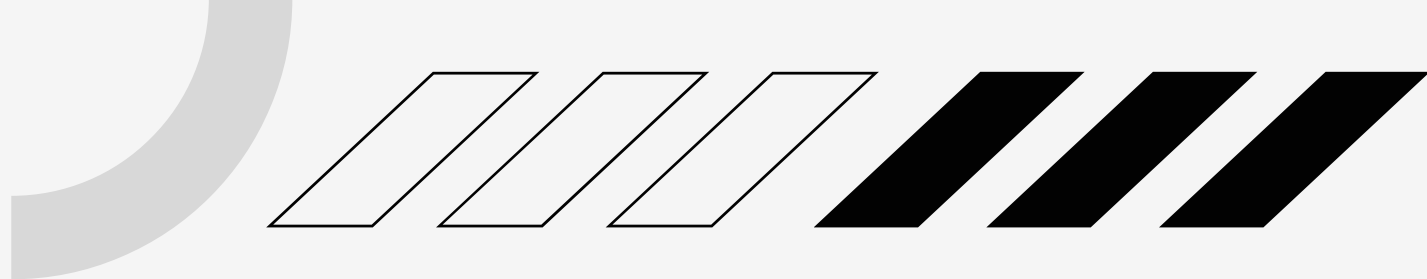
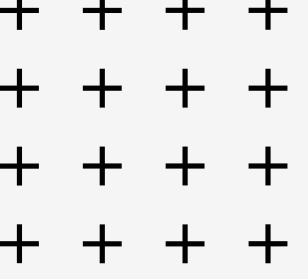

SZYNA CS

KOLORY

COLORS / FARBEN



BIAŁY



SZARY



BRAZOWY



CZARNY

APLIKACJE

APPLIKATIONS / ANWENDUNGEN

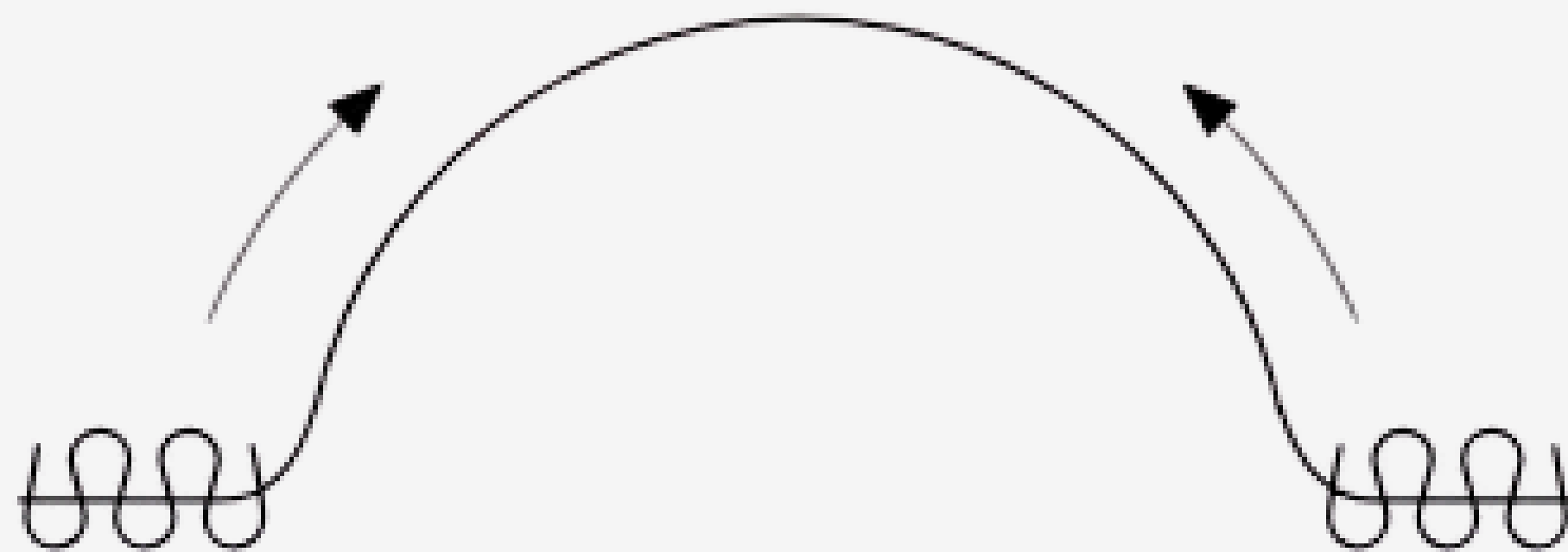
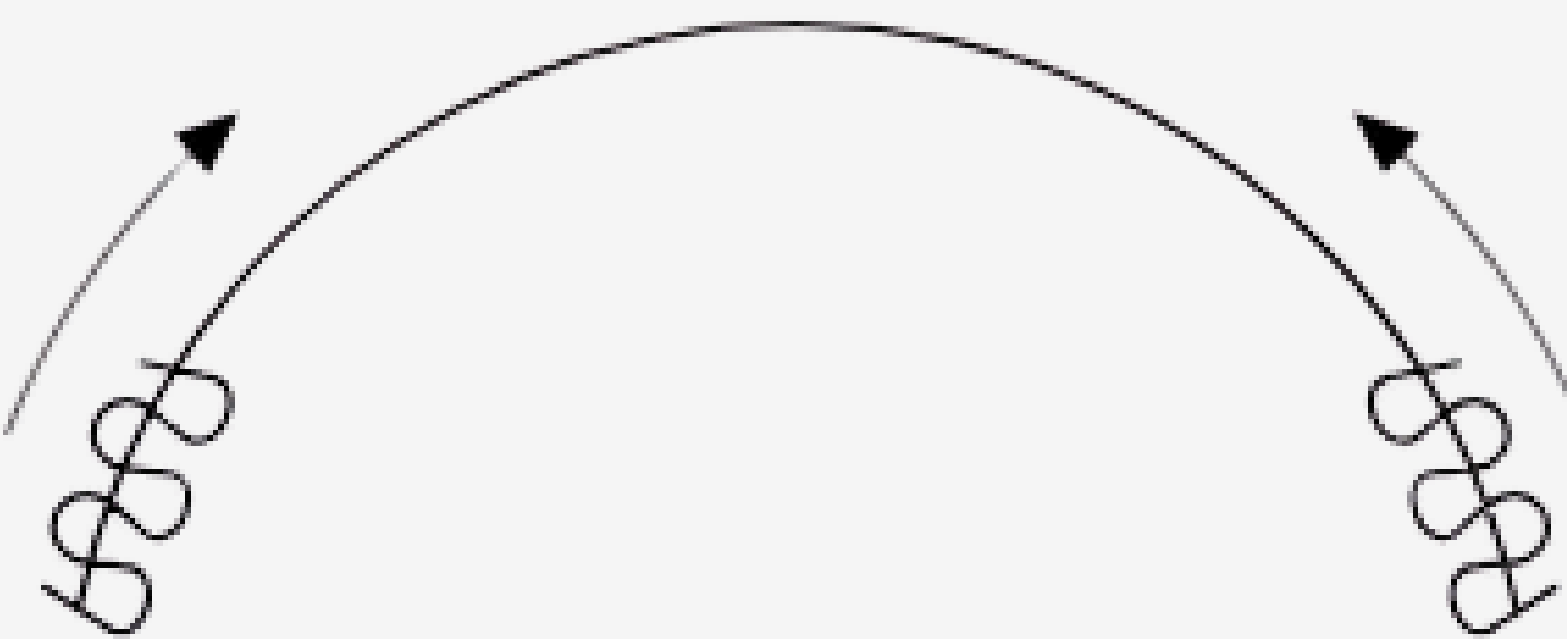
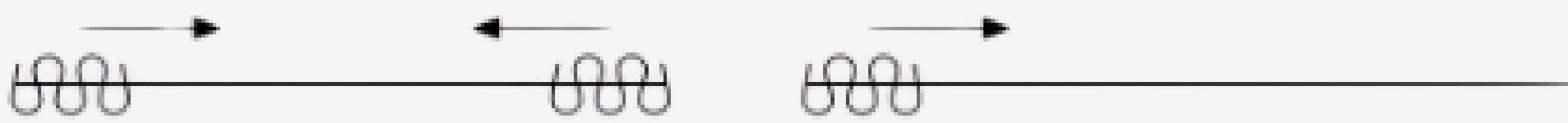

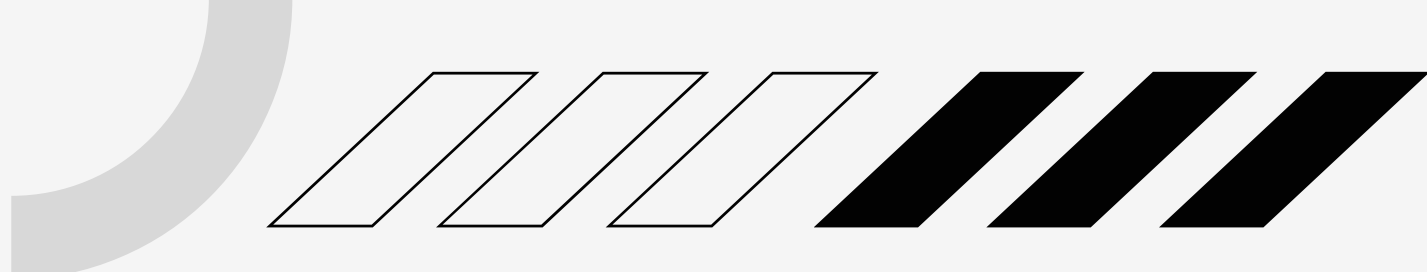
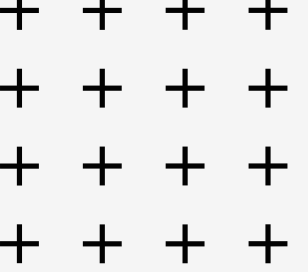

SZYNA CS

Używane w / For use in /Zur Verwendung in

Hotelach – motelach – biurach – szkołach – placówkach służby zdrowia lub w dowolnym miejscu, gdzie wymagany jest wytrzymały, ręcznie rysowany system.

Hotels - motels - offices - schools - healthcare facilities or anywhere a durable, hand-drawn system is required.

Hotels – Motels – Büros – Schulen – Gesundheitseinrichtungen oder überall dort, wo ein langlebiges, handgezeichnetes System benötigt wird.

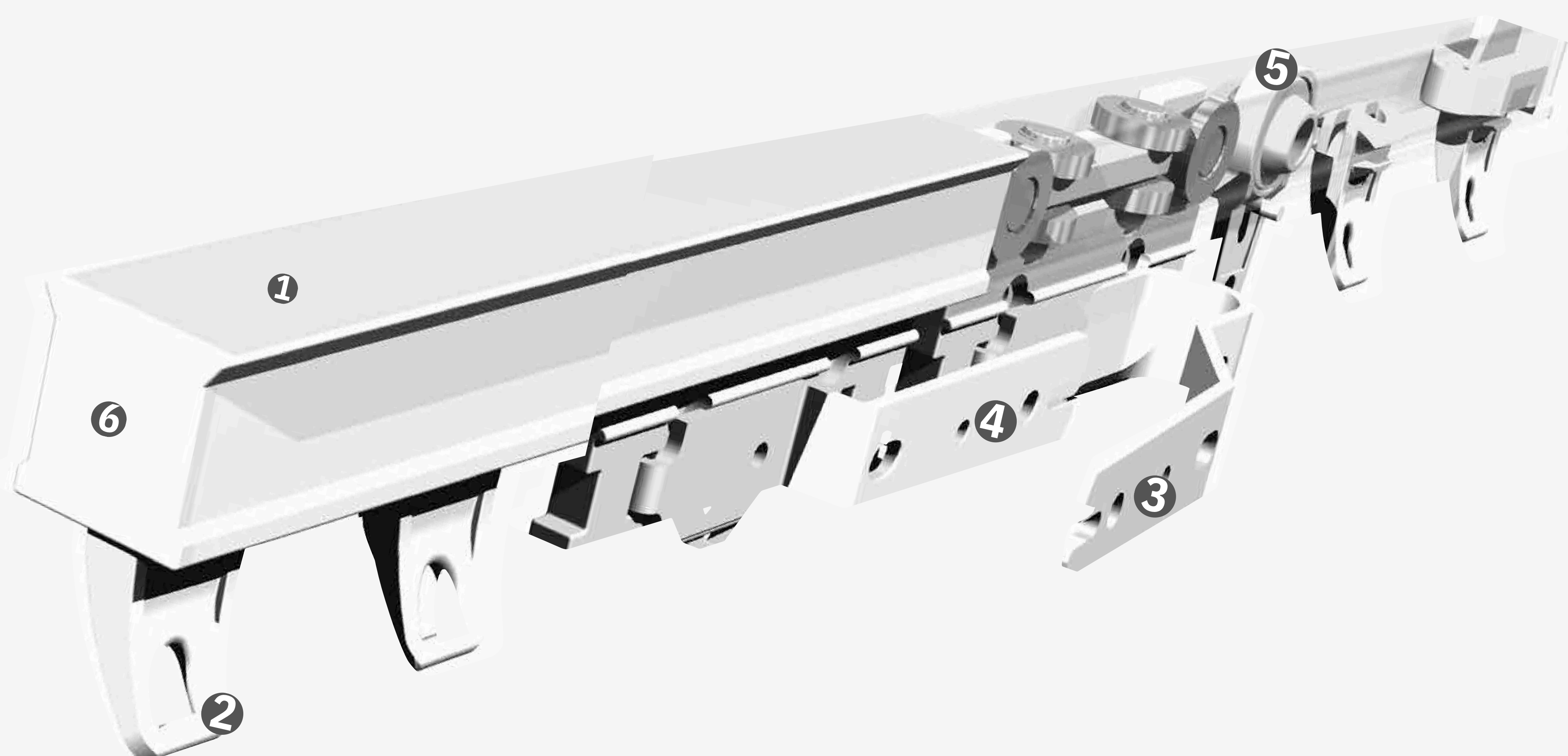

- 1 Szyna CS / CS Track / CS Schiene
- 2 Suwak / Carrier / Reißverschluss
- 3 Ramię zachodzące P / L / Master Carrier R/L Overlap / Überlappender Arm R/ L
- 4 Ramię zachodzące P / L / Master Carrier R/L Underlap / Überlappender Arm R/ L
- 5 Suwak / Carrier / Reißverschluss
- 6 Zaślepka ze śrubą / Endcap with screw / Endkappe mit Schraube

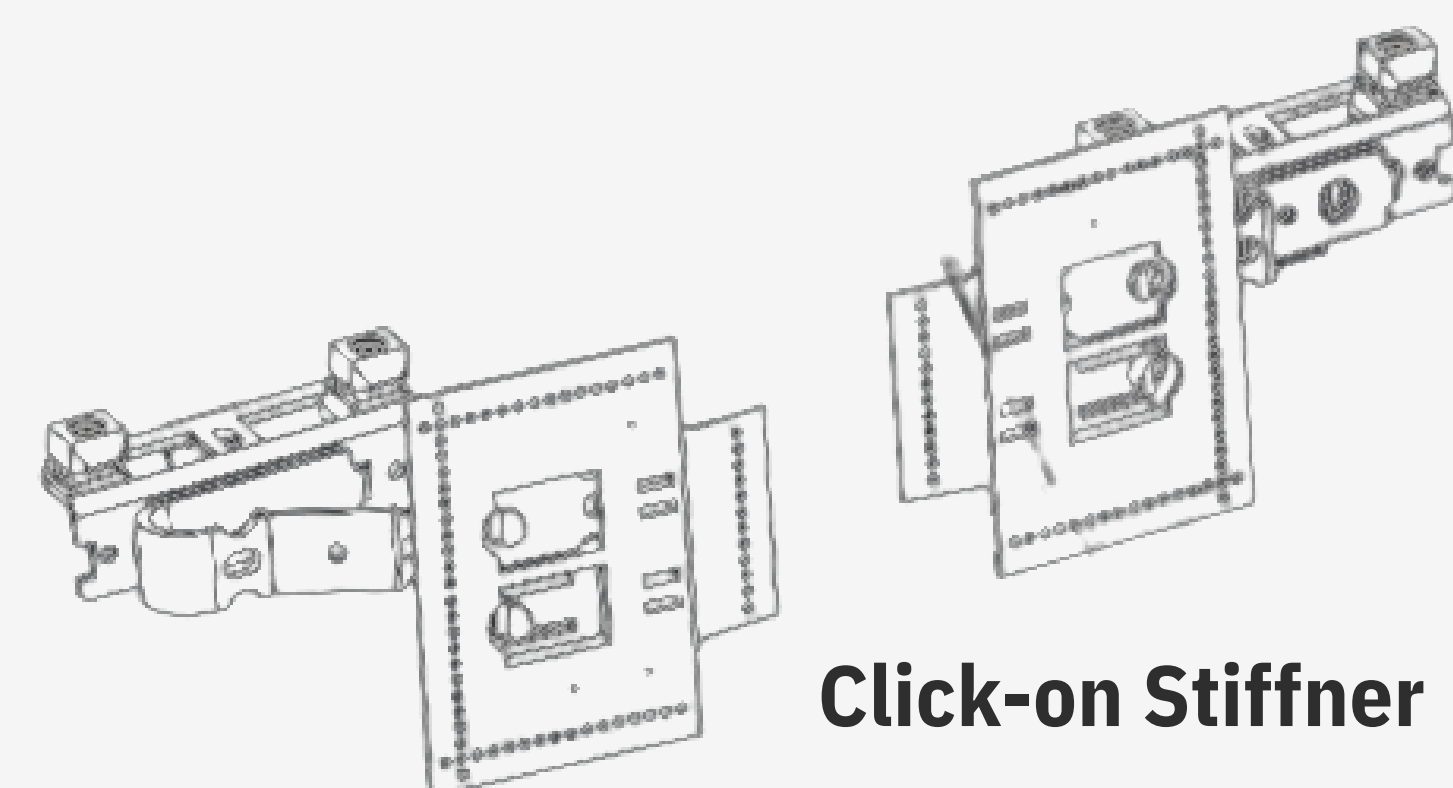

Zginanie/zakrzywianie

Tor może być zakrzywiony i odwrócony za pomocą promienia 20 cm (8”).

Za pomocą elektrycznego narzędzia do gięcia możliwe jest także ciągłe zaginanie.

Bending/curving

The track can be curved and reversed curved using a 20 cm (8”) radius.

Continuous curving is also possible with the electrical bending tool.

Biegen/Kurven

Die Strecke kann mit einem Radius von 20 cm (8 Zoll)

gebogen und umgekehrt gebogen werden. Mit dem elektrischen Biegewerkzeug sind auch kontinuierliche Kurven möglich.



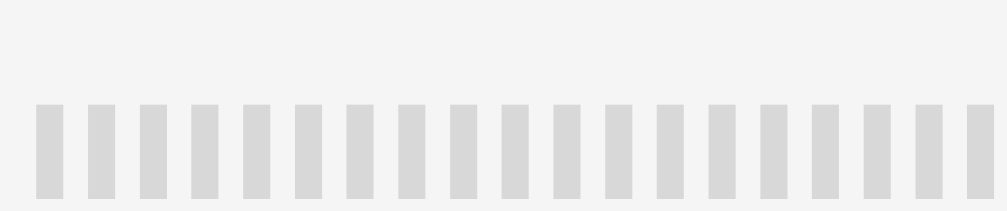
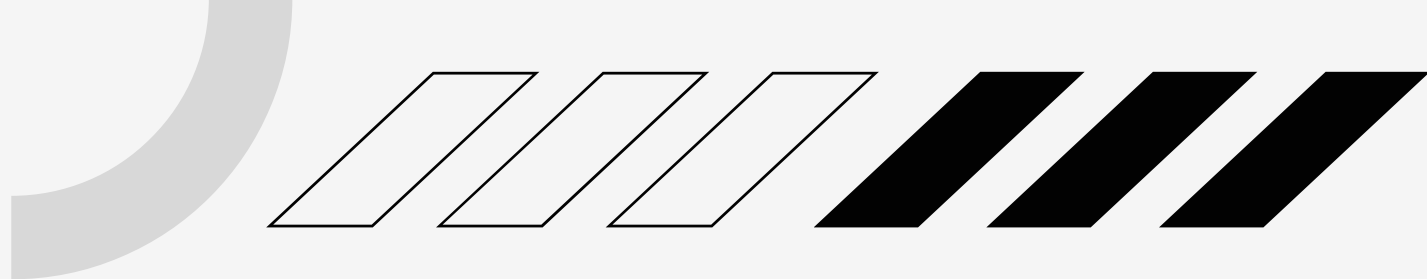
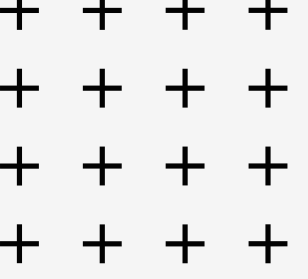

SZYNA CS

MOUNTING BRACKETS

SMART KLICK CEILING BRACKET

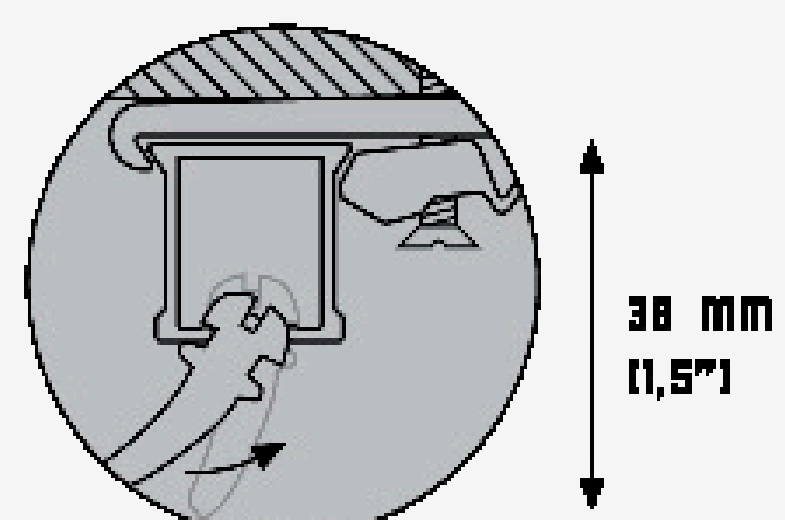
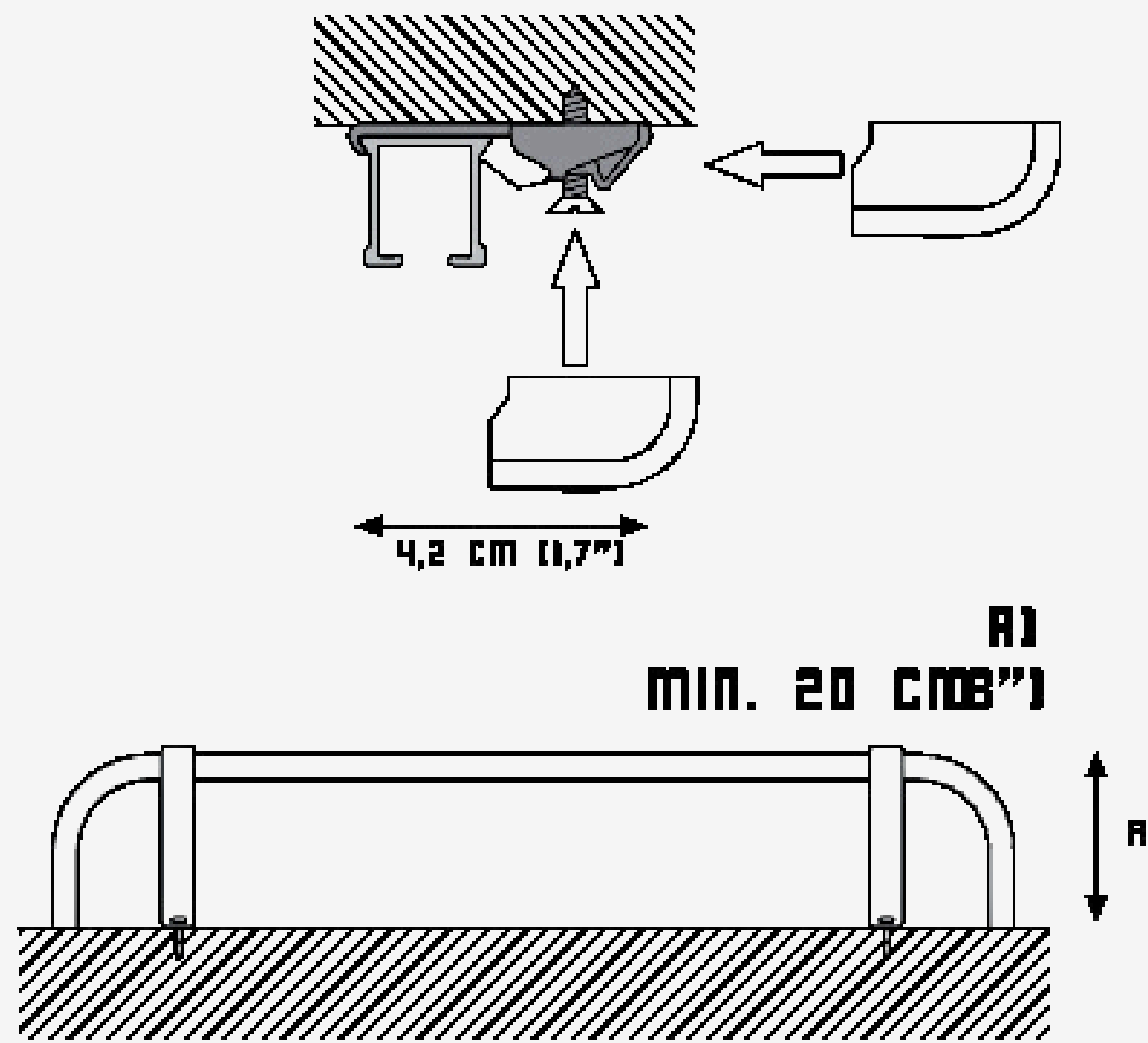

CLICKABLE CARRIER

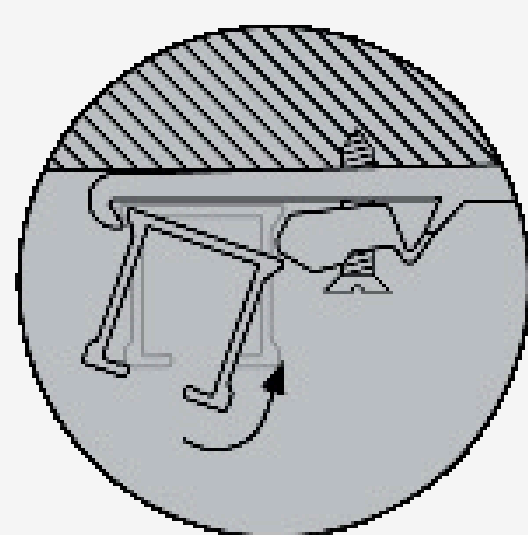

EASY INSTALLATION
CLICK - POSITION - TIGHTEN

MOUNTING BRACKETS

ALUMINIUM WALL BRACKET SINGLE

A) 7,5 cm (3") B) 6,3 cm (2,5")
 A) 10 cm (4") B) 8,8 cm (3,5")

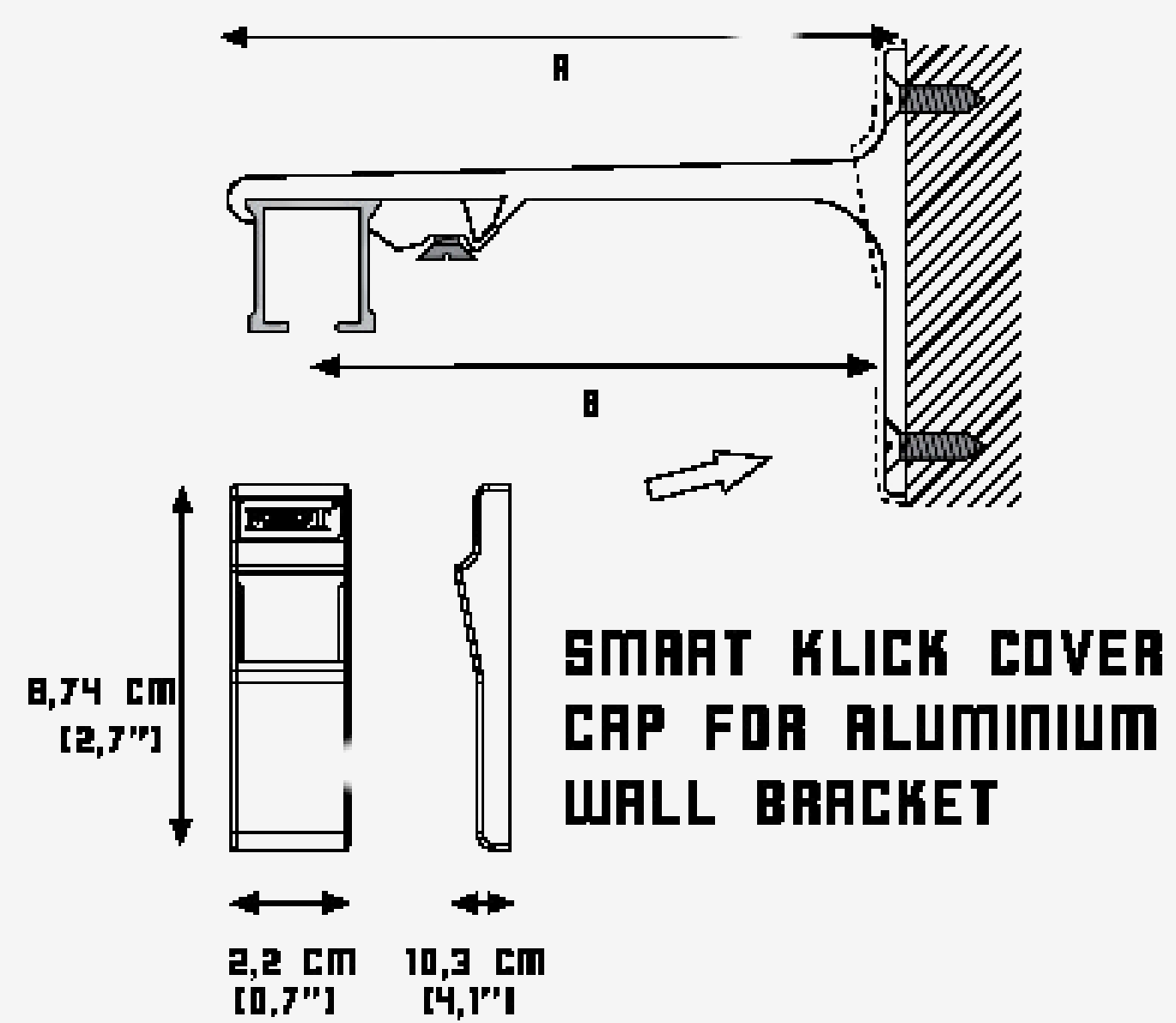

ALUMINIUM WALL BRACKET DOUBLE

A) 15 cm (6") B) 9,2 cm (3,6") C) 4,5 cm (1,8")
 A) 20 cm (8") B) 9,2 cm (3,6") C) 9,5 cm (3,7")

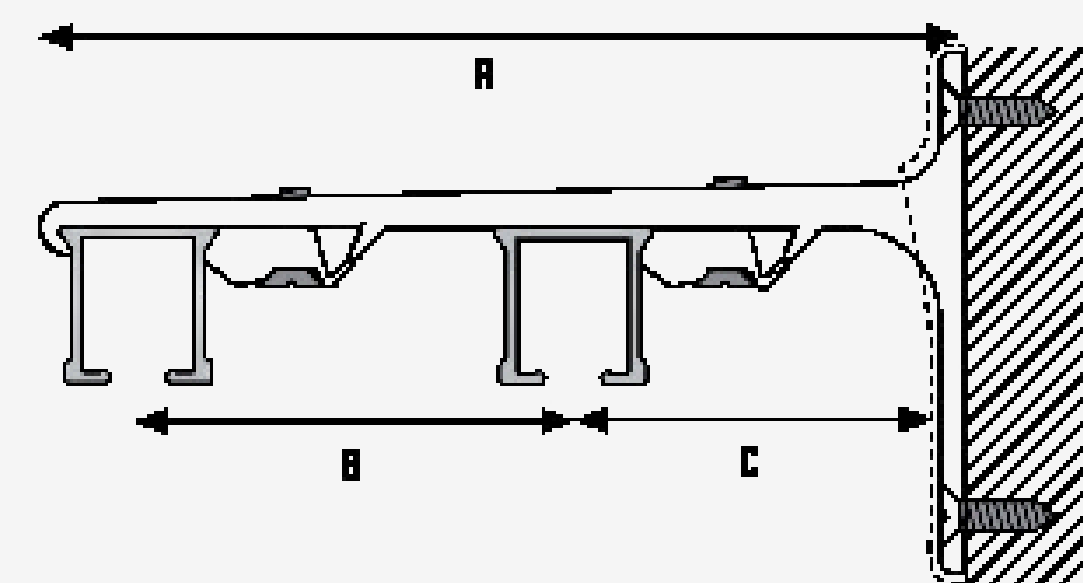

ALUMINIUM WALL BRACKET TRIPLE 25 CM (10")

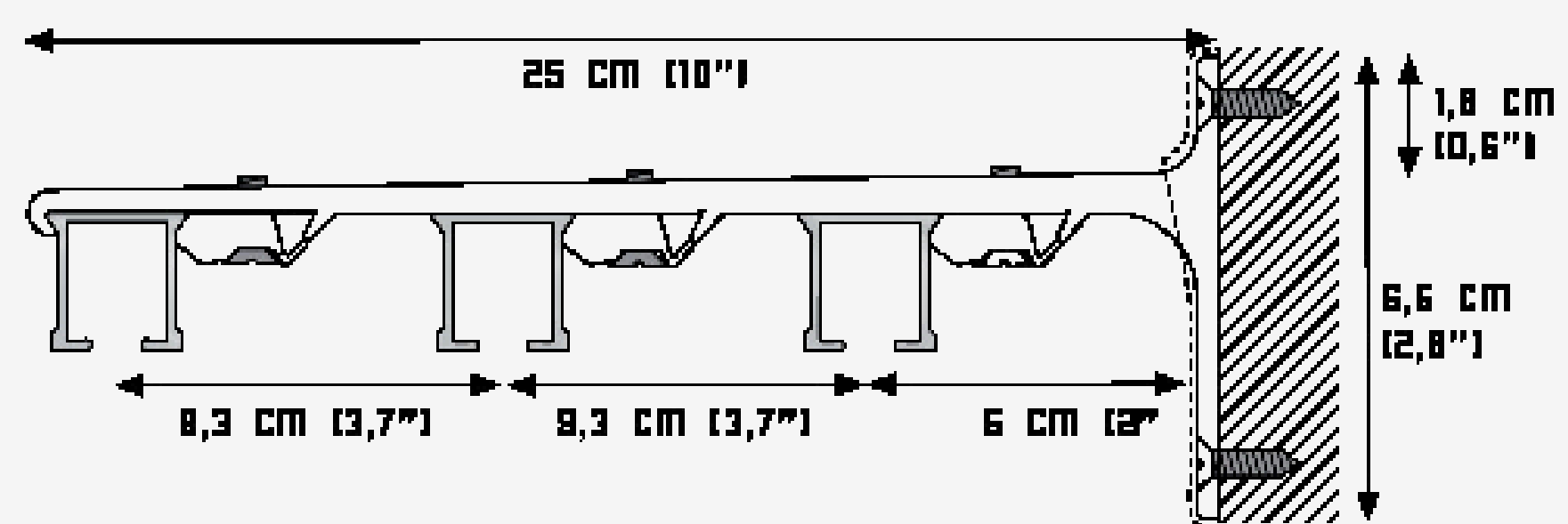

BRACKETS NEED TO BE PLACED EVERY 50 - 60 CM (24"),
DEPENDING ON FABRIC WEIGHT.



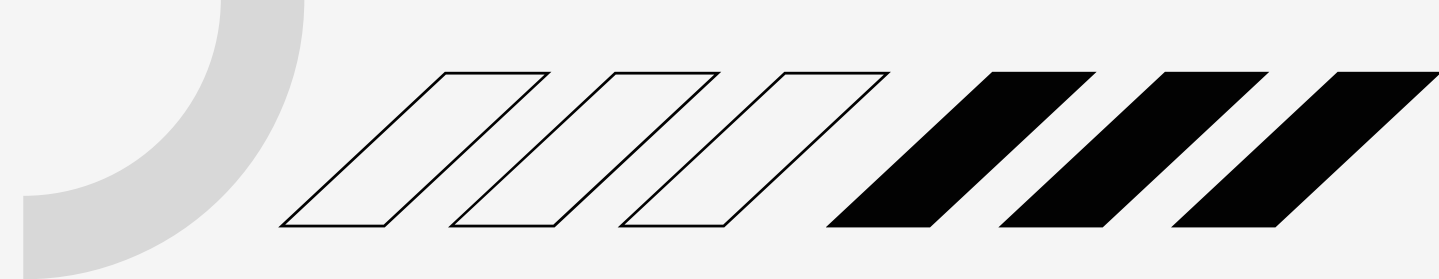
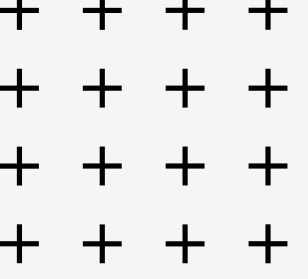

SZYNA CS

Colours available from stock:

Complete the art.nr. with the indicated colour-code

01 White, 03 Silver, 05 Brown, 06 Black

Other colours can be delivered on request.

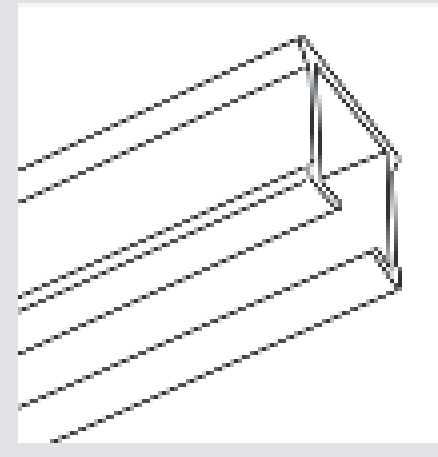

CS Track

Extruded aluminium chromated, powder coating, factory lubricated. Available lengths 3.66 m. (12'), 4.27 m. (14'), 4.88 m. (16'), 6.10 m. (20').

25010...cm
10/bundle

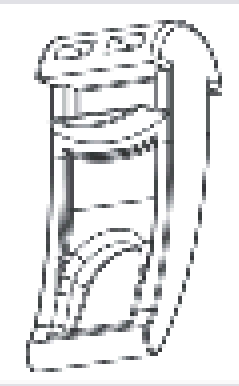

Carrier

"Clickable", offset, constructed of UV-resistant plastic. 10 Carriers on a break-away strip. Can be clicked in after installation. Colours: 01, 02, 03, 05, 06.

25101...000
250/box



CS Stop Carrier

Clickable.
Colours: 01, 03.

25102...000
100/box

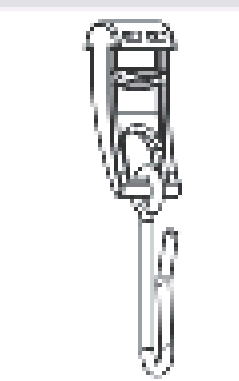

CS Carrier with Hook

Clickable.
Colours: 01.

25105...000
100/box

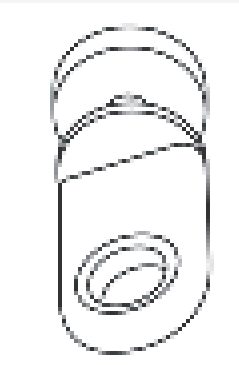

Economy Slide

Can turn in the track.
Colours: 01.

2510601000
500/box



Ball Bearing Carrier

25 mm White
20 mm White
20 mm Black
16 mm White
16 mm Black

100/box
2512100000
2512000000
2512006000
2512000016
2512006016

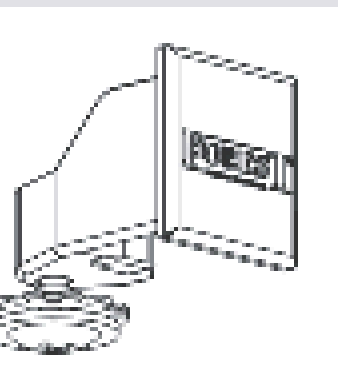

Endcap long with screw

Colours: White
Silver
Brown
Black

100/box
2516400000
2516403000
2516405000
2516406000

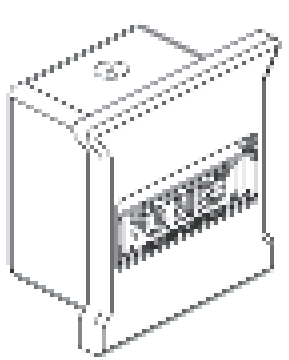

Endcap short with screw

Colours: 01, 03, 05, 06.

25164...001
100/box

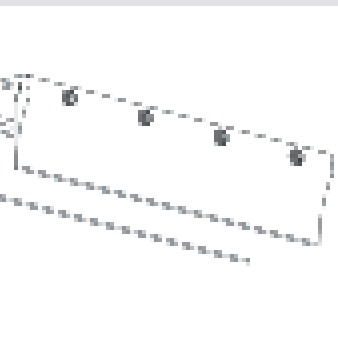

CS/CCS/FMS Track Joiner

Used to make a solid connection between two pieces of track.

Colours 01, 03, 05, 06.

25184...000
10/box

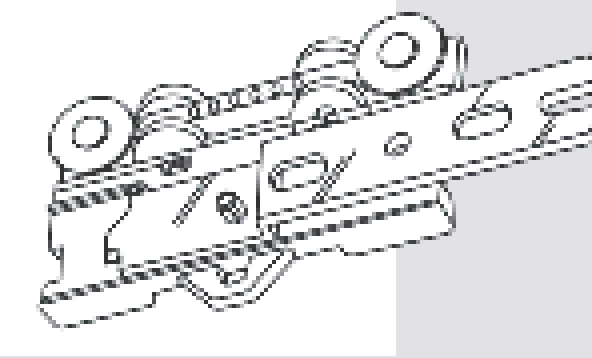

Master Carrier R/L

Underlap right or left.
Suitable for heavy drapes.
Colours: 01.

2514600000
25/box

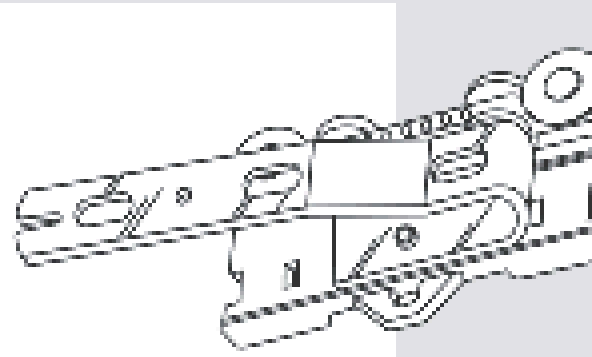

Master Carrier R/L

Overlap right or left.
Suitable for heavy drapes.
Colours: 01.

2514700000
25/box

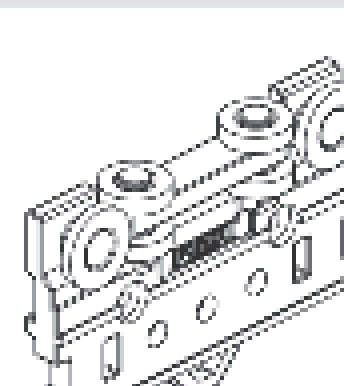

CS Master Carrier R/L Base

To be used in combination with any of the following overlap arms:

2514500000
25/box

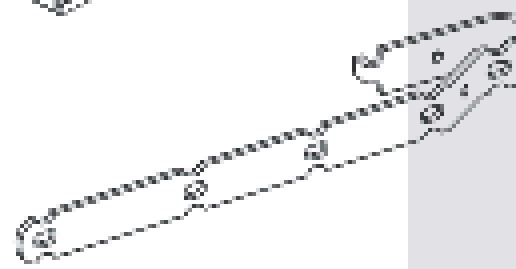

Prolonged Overlap Arm R/L
150mm for click-on stiffner

9500001010
15/box

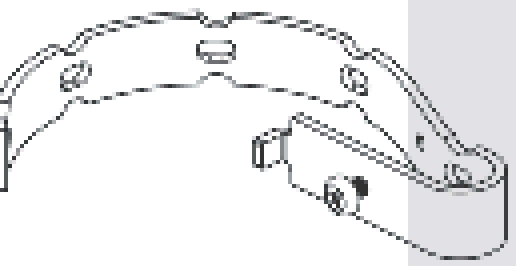

Easyflex Curved Arm R/L

5135901020
15/box15

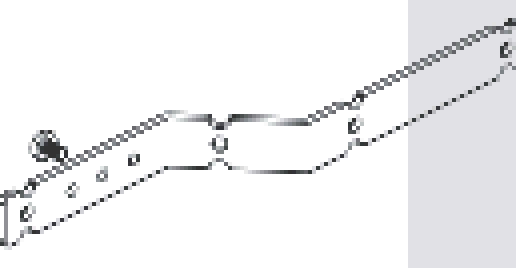

Z-Arm Universal 175mm White
R/L

9500001030
15/box

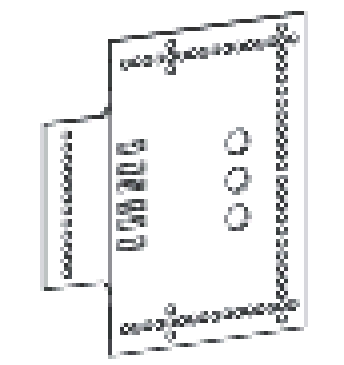

Click-on Stiffner

Recommended for additional stability of the curtain heading, to be clicked onto the master carrier arm.

5116001001
15/box

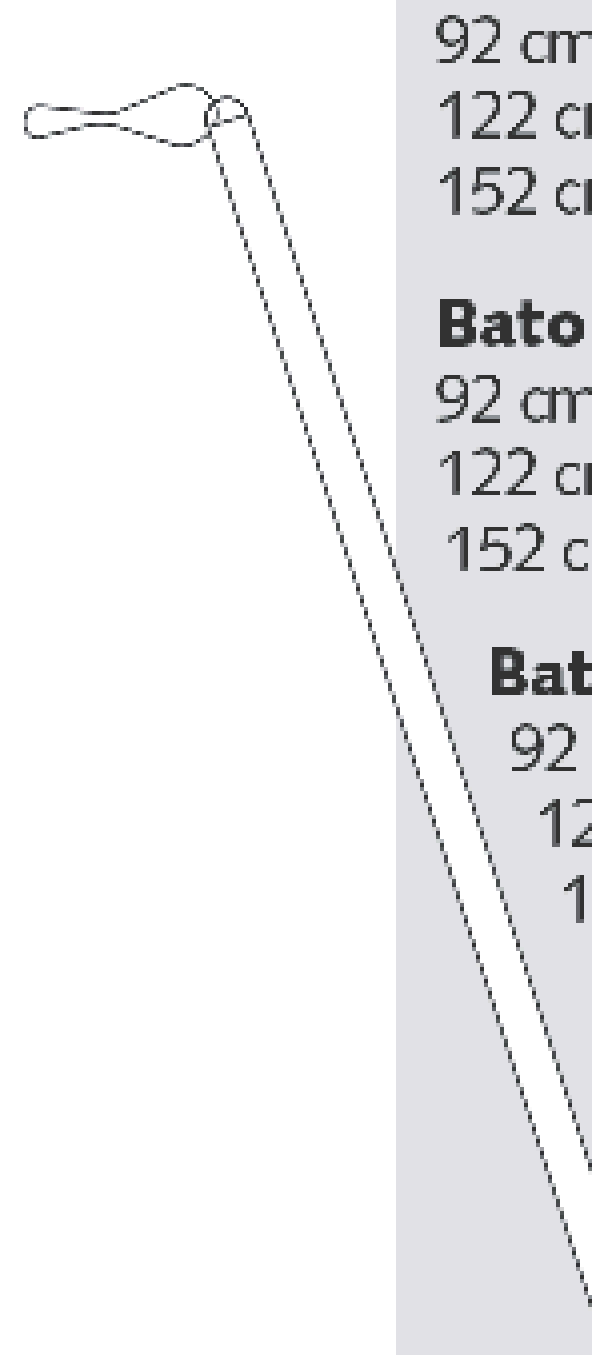

Baton Fiberglass White

92 cm (36")
122 cm (48")
152 cm (60")

1065101...
100/box

Baton Transparent

92 cm (36")
122 cm (48")
152 cm (60")

1065102...
50/box

Baton Aluminium

92 cm (36")
122 cm (48")
152 cm (60")

White
Silver
Black
Antique

1065111...
1065113...
1065116...
1065119...
50/box

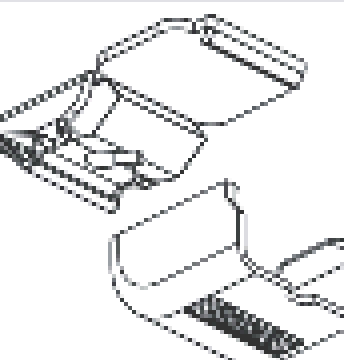





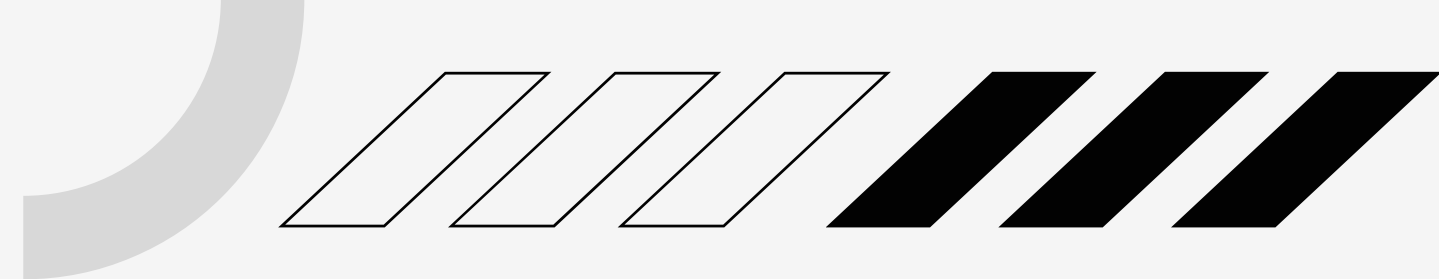
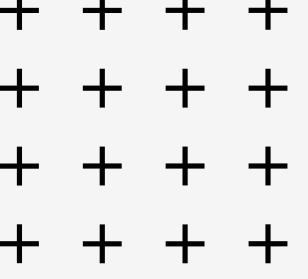

Smart Klick Ceiling Bracket

"Klicks" onto track, powder coated.
White included cover cap
Silver included cover cap
Black included cover cap

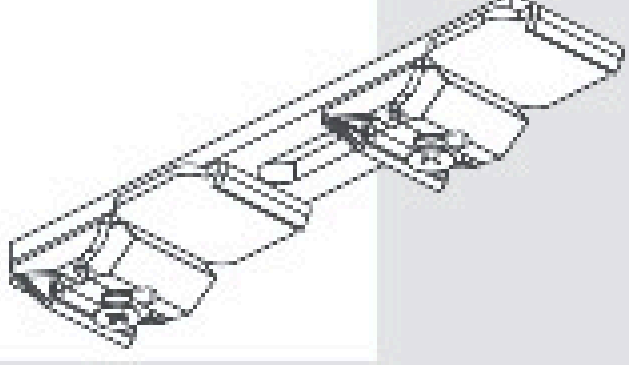
100/box
1018201001
1018203001
1018206001

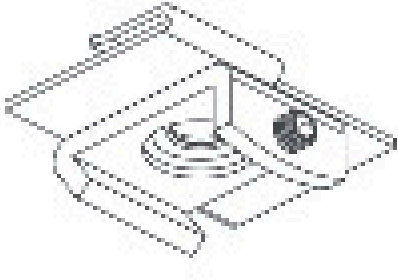
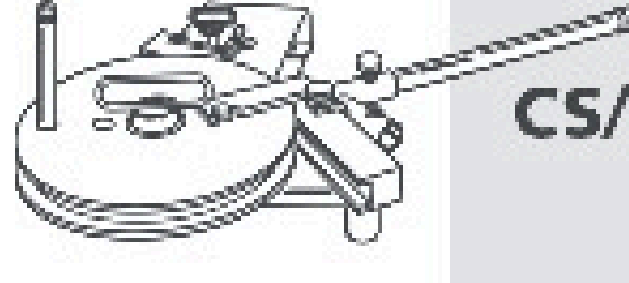
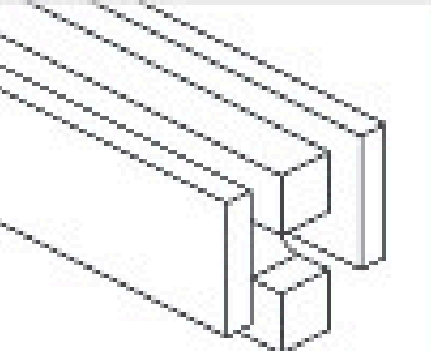
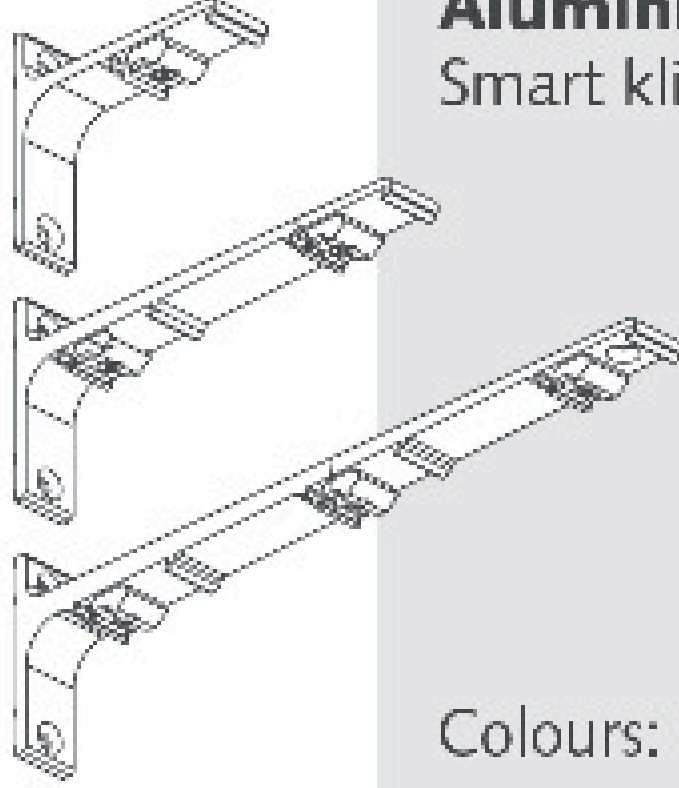
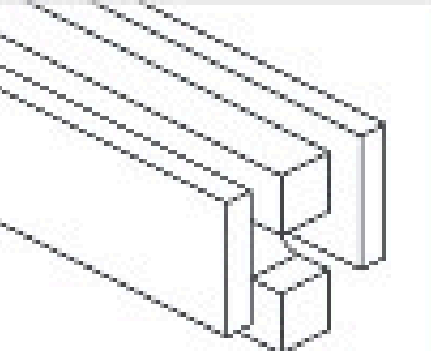
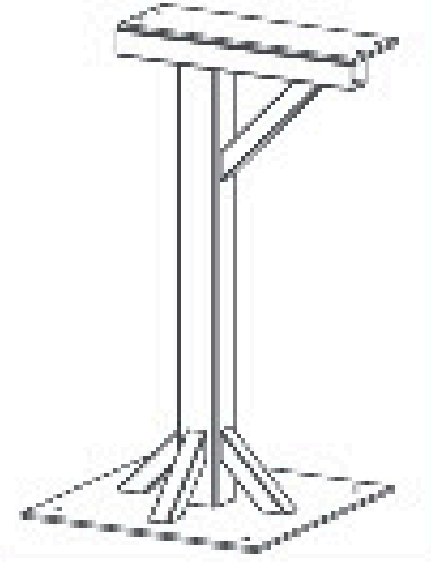
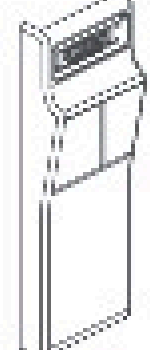
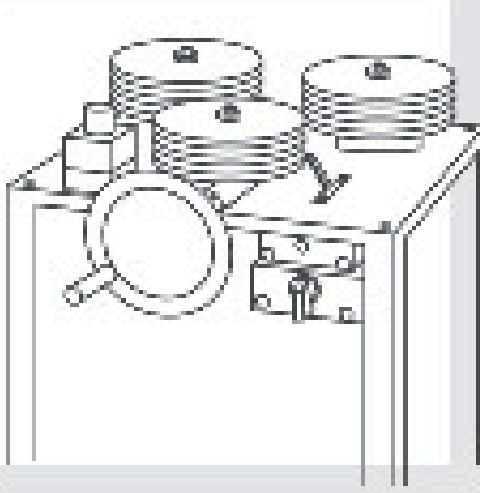
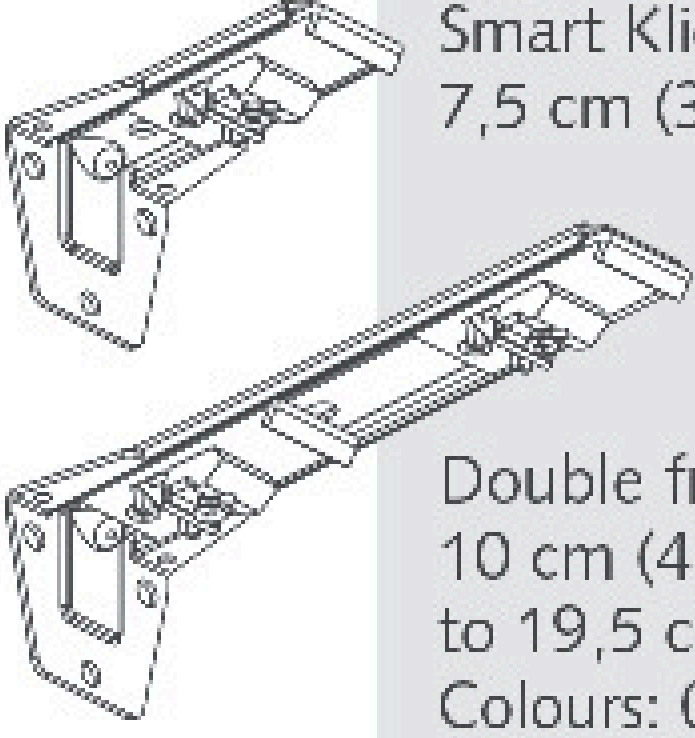
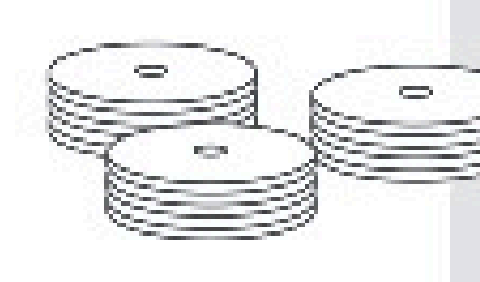
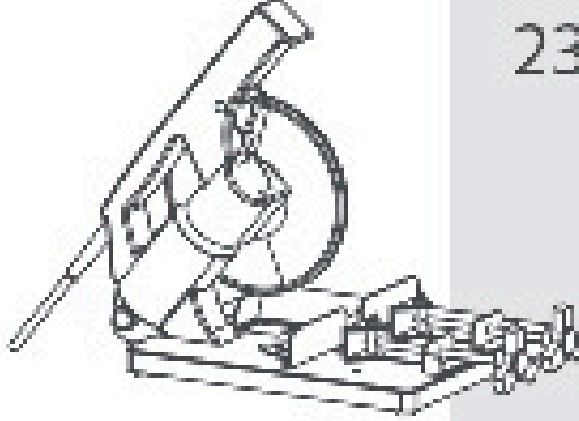
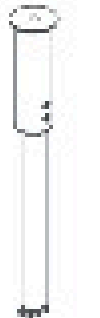

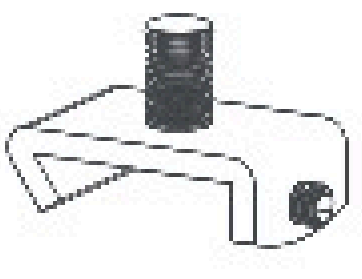
SZYNA CS

	Smart Klick Double Ceiling Bracket Large Distance between two tracks: 90 mm (3,5")	1018601000 30/box		Velcro Hotel Profile Inside frame fix, to reduce light leakage in combination with Looptape	358160160 120 mtr/bundl
	Smart Klick Double Ceiling Bracket Short Distance between two tracks: 45 mm (1,8")	1018611000 30/box			381620202 25 mtr/rc
	False Ceiling Bracket (metal) For installation on to a suspended ceiling. The track can be fixed in any angle.	100/box 4519001000		Contract Bending Tool For CS/CCS/FMS/CRS/MTS	256000000 1/eac
				CS/CCS/FMS Bending Wheel	256100000 1/eac
	Aluminium Wall Bracket Smart Klick, powder coated.	10203.. ... mm		CS Bending Strips For CS track, length: 90 cm (35,4")	850000000 1/se
	7,5 cm single (3")	20/box		For CS electric powered bender. Length 7 meter (23').	516060000 1/se
	10 cm single (4")	20/box			
	15 cm double (6")	15/box			
	20 cm double (8")	15/box			
	25 cm triple (10")	10/box			
	Colours: 01, 03.			Bending Stand Stand for contract bending tool	256080000 1/eac
	Smart Klick Cover Cap Alu Wall Bracket Universal Colours: 01, 03, 06.	10213..000 50/box		Electric Powered Bender Available in 230V or 115V, to create continuous curves and arches. Minimum radius 50 cm (20").	106050000 1/bo
	Adjustable Wall Bracket Smart Klick, adjustable single from 7,5 cm (3") to 11,5 cm (4,5")	10208..115 100/box		Bending Wheels For Electric Powered Bender. Complete set of 3 wheels.	256070000 1/se
	Double from 6,5 cm (2,5") to 10 cm (4") - 15 cm (6") to 19,5 cm (7,5")	10208..195 50/box			
	Colours: 01.			Electric Powered Railcutter 230 Volt EU	106110000 1/eac
	MTS Suspension Ceiling Bracket Length: 10 cm (4") - 1 m (3,3') 1 m (3,3') - 1,5 m (4,9')	4518201000 4518201500 1/each		Replacement Blade For electric powered railcutter.	106120000 1/eac
	Suspension Bracket Clip To be used in combination with the Suspension Ceiling Bracket	1016901000 50/box		Forest Lubricant To lubricate components during assembly.	510901000 1/bo

